

Pro Series Channel

Sold by the piece

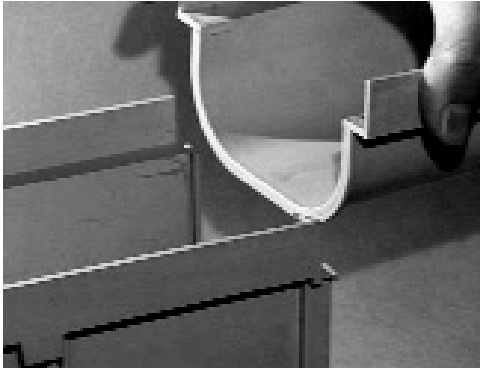

Mechanical Interlocking Joints

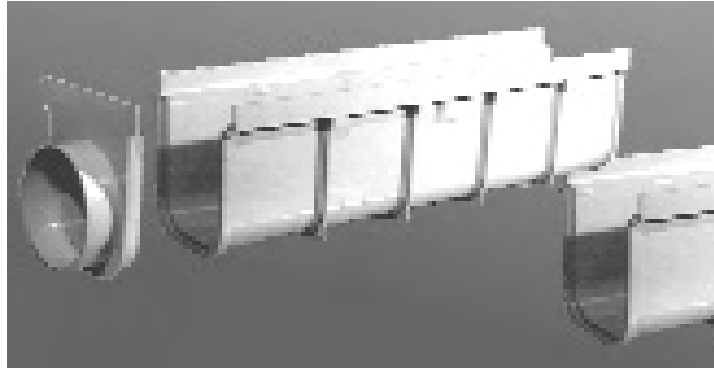

Modular Design Allows Flexibility

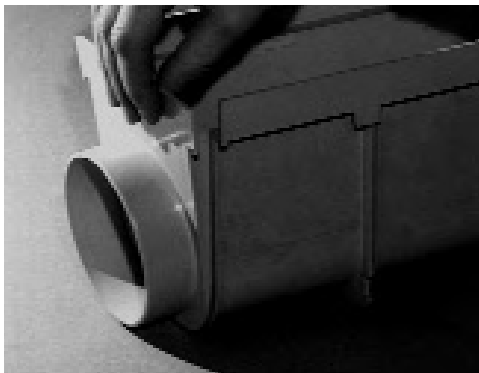

End Cap/Knock Out End Outlet Combination fitting

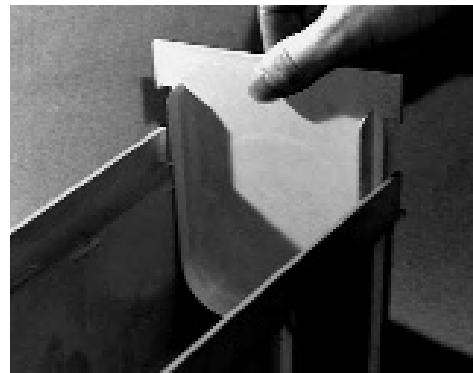

End Cap/End Outlet Slides into Interlocking Joints

- Flexible and easy: side and bottom outlets can be inserted at any location along the channel run.

Details

- Create a channel as long as you need, to lengths as short as 4" for smaller, interlocking sections.
- End cap/knock-out end and outlet fitting simplifies assembly and installation.
- Flexible and easy: side and bottom outlets can be inserted at any location along the channel run.
- Available in four widths: 3", 5", 8" and 1
- Available in two depths: deep for heavy flows, shallow for slabs or where little fall depth is available.
- Modular design comes in ½ meter (19 7/8") and 1 meter (39 3/4") pieces with interlocking end joints.
- Joints eliminate couplings and are specially designed to withstand concrete expansion and contraction.

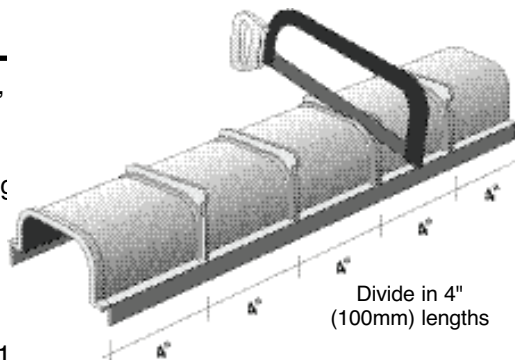

rate, channel and component parts include UV inhibitors to prevent fading and cracking.

- Load Star grate is designed with a patented multi-link I-beam structure providing the strength of traditional cast iron grates.

Materials and Standards

- PVC solvent cement creates a structurally-compact, water-tight channel.

Load Recommendations

- Pedestrian Grates offer heel-proof pattern.
- Polyolefin Light Vehicular Grate for use in areas with passenger vehicles and light trucks with speeds less than 20 MPH.
- Load Star Glass-Filled Reinforced-Nylon Heavy Traffic Grate for use in areas with tractor-trailer and pneumatic forklift traffic with speeds less than 20 MPH.
- See individual products for details.

Note: All dimensions are nominal. All weights are for shipping purposes only. Availability is subject to change.

Pre-assembled Channel Drain Systems

The pre-assembled Modular Pro Series channel drains are efficient, easy to use and will decrease installation time. They quickly remove water from hardscapes as perimeter drains and direct it away from building structures or any other area requiring surface drainage.

The new 3" and 5" wide pre-assembled channel drains include a one meter (39 3/4") of channel drain and grate, 1 end outlet, and 1 end cap. A bottom outlet is built into each channel section. This allows for easy ordering and less inventorying, as everything is included under one part number.

Our unique Pro Series interlocking channel design allows each channel to securely lock to the next for a secure, tight fit. This innovative and patented design eliminates the need for couplings. The pre-assembled Pro Series Channel drains are a great solution for your drainage needs.

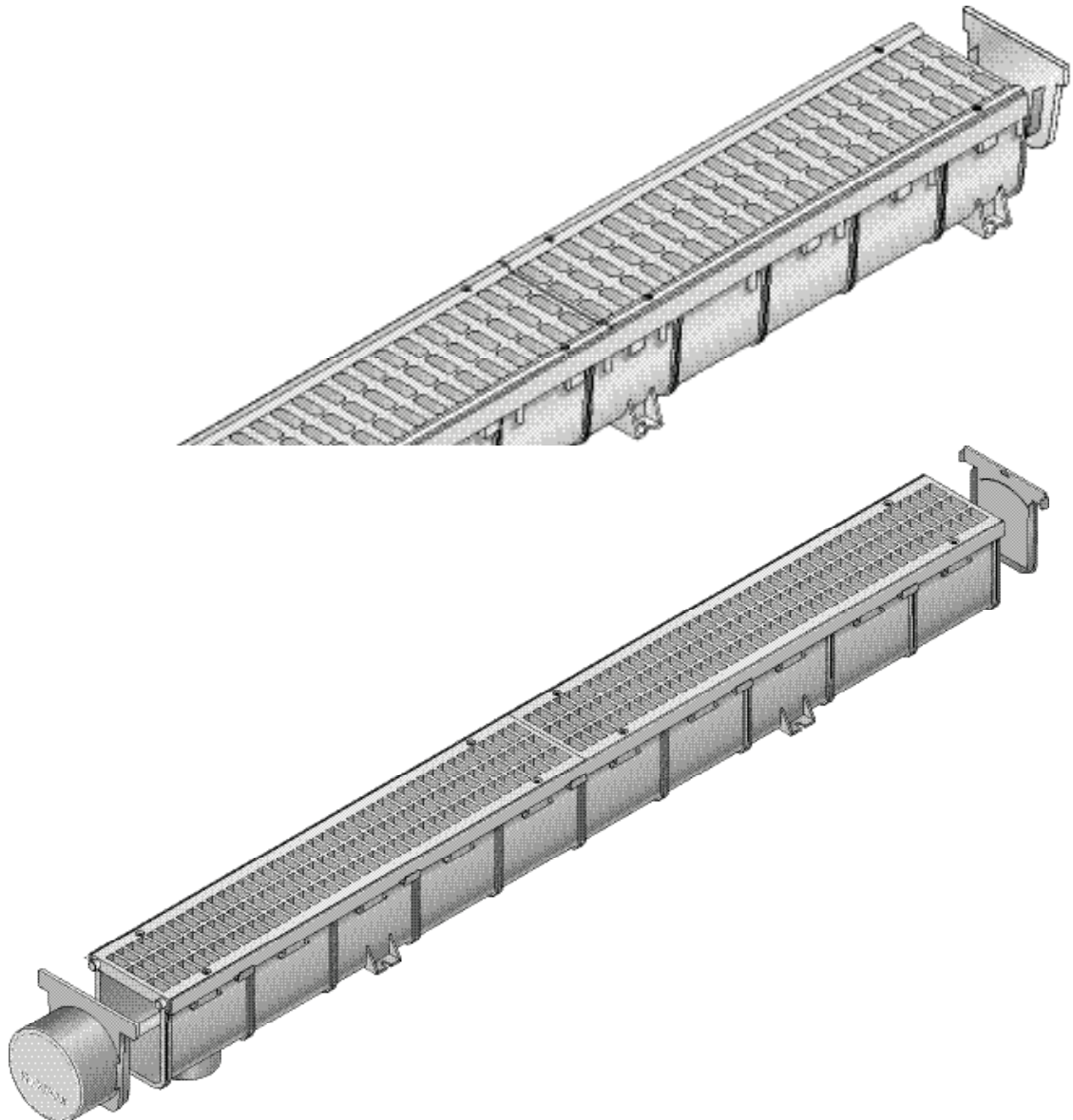

3" PRO SERIES CHANNEL™ DRAINS

Patented

MODULAR CHANNEL DRAINS

Part No.	Description	Color	Pkg. Qty.	Wt. Ea. (lbs.)	Product Class	Specifications
764	3" x 1 Meter Light Traffic Channel Grate & Channel Drain Kit Includes 1 end outlet (#713) and 1 end cap (#712) Bottom outlet fits 3" S&D fittings.	Light Gray	10	3.75	25IN	NDS #764, 3" wide high impact PVC light traffic channel grate and high impact PVC Channel Drain with mechanical interlocking joints and UV inhibitors. Open surface area 20.44 square inches per foot. 26.77 GPM per foot.

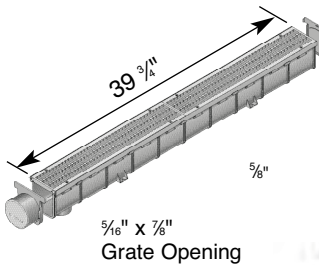

39 3/4"
5/8"
5/16" x 7/8"
Grate Opening

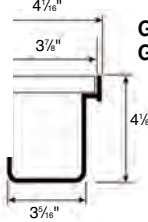

4 1/16"
3 3/8"
4 1/8"
3 5/16"

Grate should be recessed 1/8" below finish grade in non traffic applications.
Grate should be recessed 1/4" in traffic applications.



(See pg. 47)

ADA Compliant

Part No.	Description	Color	Pkg. Qty.	Wt. Ea. (lbs.)	Product Class	Specifications
710	3" x 1 Meter Channel Drain* Bottom outlet fits 3" S&D fittings. Grate should be recessed 1/8" below finish grade in non traffic applications. Grate should be recessed 1/4" in traffic applications.	Light Gray	12	2.50	25IN	NDS #710, 3" wide high impact PVC Channel Drain with mechanical interlocking joints.

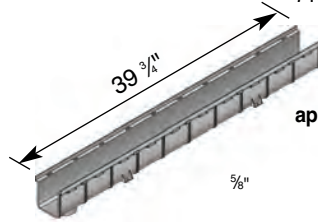

39 3/4"
5/8"

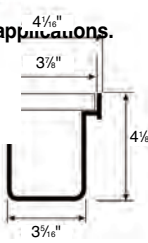

4 1/16"
3 3/8"
4 1/8"
3 5/16"



(See pg. 47)

Part No.	Description	Color	Pkg. Qty.	Wt. Ea. (lbs.)	Product Class	Specifications
714	3" x 20" Light Traffic Channel Grate* ADA Compliant	Light Gray	24	1.00	25IN	NDS #714, 3" wide high impact PVC light traffic channel grate. Open surface area 20.44 square inches per foot. 26.77 GPM per foot.

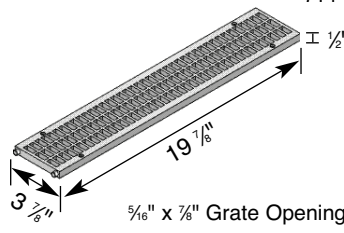

1/2"
19 1/8"
3 7/8"
5/16" x 3/8" Grate Opening



(See pg. 47)

ADA Compliant

Part No.	Description	Color	Pkg. Qty.	Wt. Ea. (lbs.)	Product Class	Specifications
713	3" End Cap/End Outlet Fits 3" fittings	Light Gray	12	0.25	25IN	NDS #713, 3" high impact PVC End Cap/End Outlet.



1 3/8"
3 7/8"

Part No.	Description	Color	Pkg. Qty.	Wt. Ea. (lbs.)	Product Class	Specifications
712	3" End Cap	Light Gray	20	0.10	25IN	NDS #712, 3" high impact PVC End Cap.

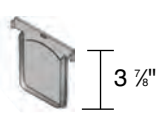

3 7/8"

Note: All dimensions are nominal. All weights are for shipping purposes only. Availability is subject to change.

*Produced under license of First Plast S.R.L.- Italy

Part No.	Description	Color	Pkg. Qty.	Wt. Ea. (lbs.)	Product Class	Specifications
864	5" x 1 Meter Light Traffic Grate & Channel Drain Kit Includes 1 end outlet & 1 end cap	Light Gray	9	7.11	25IN	NDS #864, 5" Wide Structural Foam Polyolefin light traffic channel grate and deep profile high impact PVC channel drain with mechanical interlocking joint and UV inhibitors. Open surface area 25.12 square inches per foot. 32.91 GPM per foot.

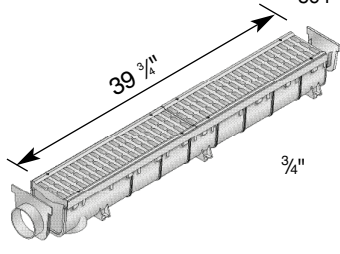

39 3/4"
3/8" x 1 1/4"
Grate Opening

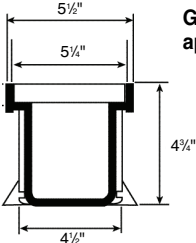

5 1/2"
5"
4 1/4"
4"

Grate should be recessed 1/8" below finish grade in non traffic applications. Grate should be recessed 1/4" in traffic applications.



(See pg. 47)

Bottom outlet fits 3" and 4" S&D fittings

Part No.	Description	Color	Pkg. Qty.	Wt. Ea. (lbs.)	Product Class	Specifications
826	5" x 20" Pedestrian Traffic Channel Grate Requires #829 screws.	Light Gray	10	1.00	25IN	NDS #826, 5" Wide UV protected high impact Polyolefin pedestrian traffic channel grate. Open surface area 7.93 square inches per foot. 10.39 GPM per foot.

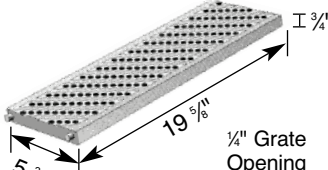

19 5/8"
1/4" Grate Opening



(See pg. 47)

ADA Compliant/Heel-proof

Part No.	Description	Color	Pkg. Qty.	Wt. Ea. (lbs.)	Product Class	Specifications
814	5" x 20" Light Traffic Channel Grate	Light Gray	10	1.20	25IN	NDS #814, #815, #816, #817, #818, #819, 5" Wide Structural Foam Polyolefin light traffic channel grate with UV inhibitors. Open surface area 25.12 square inches per foot. 32.91 GPM per foot.
815	5" x 20" Light Traffic Channel Grate	Green	10	1.20	25IN	
816	5" x 20" Light Traffic Channel Grate	Black	10	1.2	25IN	
817	5" x 20" Light Traffic Channel Grate	Sand	10	1.20	25IN	
818	5" x 20" Light Traffic Channel Grate	Brick Red	10	1.20	25IN	
819	5" x 20" Light Traffic Channel Grate	White	10	1.20	25IN	

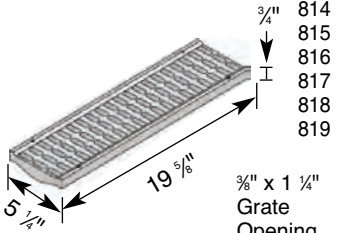

19 5/8"
3/8" x 1 1/4"
Grate Opening

Requires #829 screws.



(See pg. 47)

ADA Compliant

Part No.	Description	Color	Pkg. Qty.	Wt. Ea. (lbs.)	Product Class	Specifications
828	5" x 20" Load Star Heavy Traffic Channel Grate Requires 4 Screws per Grate Requires #829 screws.	Gray	10	2.0	25IN	NDS #828, 5" Wide UV protected high impact glass reinforced nylon heavy traffic channel grate. Open surface area 15.54 square inches per foot. 20.36 GPM per foot.

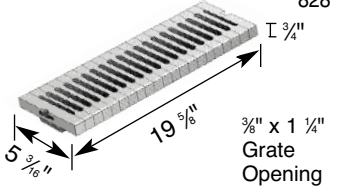

19 5/8"
3/8" x 1 1/4"
Grate Opening



(See pg. 47)

ADA Compliant

Part No.	Description	Color	Pkg. Qty.	Wt. Ea. (lbs.)	Product Class	Specifications
823	5"x20" Cast Iron Channel Grate	Black	1	10.00	25IN	NDS #823, 5" Wide Heavy Duty Cast Iron Heavy Traffic Channel Grate. Open surface area 25.03 square inches per foot. 32.79 GPM per foot.

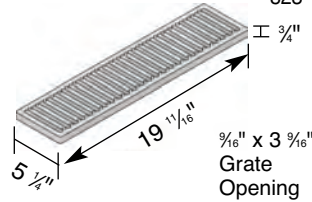

19 1/16"
3/16" x 3 3/16"
Grate Opening

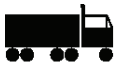

(See pg. 47)

Part No.	Description	Color	Pkg. Qty.	Wt. Ea. (lbs.)	Product Class	Specifications
829	Stainless Steel Screws, FH #6 x 1 1/4"	Steel	40	.15	25PF	



5" PRO SERIES CHANNEL™ DRAINS

Patented

MODULAR CHANNEL DRAINS

*Produced under license of First Plast S.R.L.- Italy

Part No.	Description	Color	Pkg. Qty.	Wt. Ea. (lbs.)	Product Class	Specifications
820	5" x 20" Shallow Profile Channel Drain*	Light Gray	10	1.35	25IN	NDS #820, 5" Wide Shallow Profile UV protected high impact PVC Channel Drain with Mechanical Interlocking Joint.

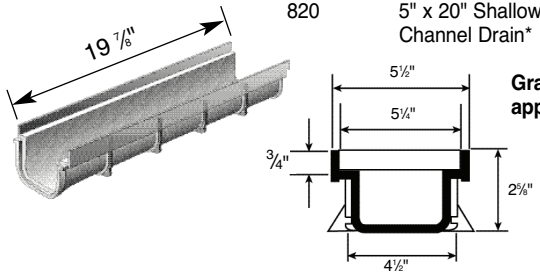

Grate should be recessed 1/8" below finish grade in non traffic applications. Grate should be recessed 1/4" in traffic applications.

Part No.	Description	Color	Pkg. Qty.	Wt. Ea. (lbs.)	Product Class	Specifications
821	5" Shallow Profile End Cap/ 1-1/2" SCH 40 SPT Knock Out End Outlet*	Light Gray	10	0.15	25IN	NDS #821, 5" Wide Shallow Profile high impact PVC End Cap/End Outlet.



Part No.	Description	Color	Pkg. Qty.	Wt. Ea. (lbs.)	Product Class	Specifications
822	5" Shallow Profile 3" S&D SPT Bottom Outlet/ 1-1/2" SCH 40 SPT Side Outlet	Light Gray	10	0.60	25IN	NDS #822, 5" Wide Shallow Profile high impact PVC Bottom/Side Outlet.

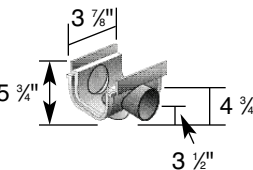

Part No.	Description	Color	Pkg. Qty.	Wt. Ea. (lbs.)	Product Class	Specifications
800	5" x 1 Meter Deep Profile Channel Drain	Light Gray	10	4.00	25IN	NDS #800, 5" Wide Deep Profile high impact PVC Channel Drain With Mechanical Interlocking Joints, Installation feet, integrated knock out bottom outlet.

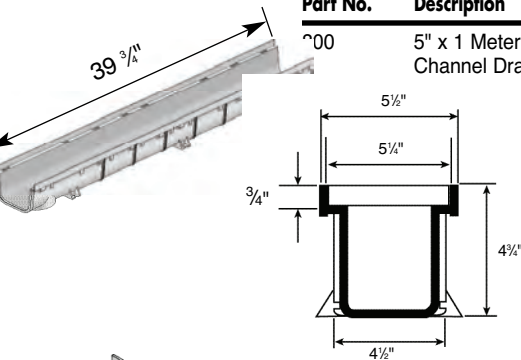

egrated Knock out bottom outlet fits 3" and 4" S&D Fittings.

ate should be recessed 1/8" below finish grade in non traffic applications. Grate should be recessed 1/4" in traffic applications.

Part No.	Description	Color	Pkg. Qty.	Wt. Ea. (lbs.)	Product Class	Specifications
811	5" Deep Profile 3" S&D Pipe Hub & 4" S&D Fitting SPT End Outlet	Light Gray	10	0.40	25IN	NDS #811, 5" Wide Deep Profile high impact PVC End Outlet.

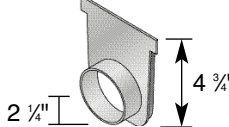

Part No.	Description	Color	Pkg. Qty.	Wt. Ea. (lbs.)	Product Class	Specifications
813	5" Deep Profile End Cap/3" S&D Hub & 4" S&D SPT Knock Out End Outlet	Light Gray	10	0.40	25IN	NDS #813, 5" Wide Deep Profile high impact PVC End Cap/End Outlet.

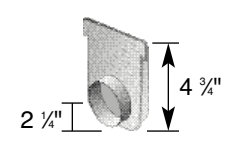

Part No.	Description	Color	Pkg. Qty.	Wt. Ea. (lbs.)	Product Class	Specifications
812	5" Deep Profile End Cap	Light Gray	10	0.20	25IN	NDS #812, 5" Wide Deep Profile high impact PVC End Cap.

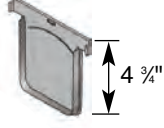

Part No.	Description	Color	Pkg. Qty.	Wt. Ea. (lbs.)	Product Class	Specifications
861	5" Deep Profile Grate & Channel Drain 90 Degree Elbow	Light Gray	1	3.44	25IN	

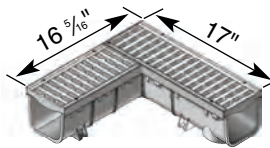

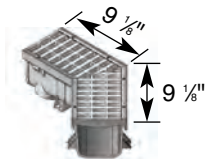

Part No.	Description	Color	Pkg. Qty.	Wt. Ea. (lbs.)	Product Class	Specifications
862	5" Deep Profile Grate & Channel Drain 45 Degree Elbow	Light Gray	1	3.44	25IN	



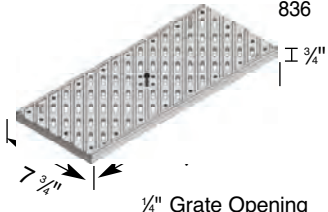

Note: All dimensions are nominal. All weights are for shipping purposes only. Availability is subject to change.

*Produced under license of First Plast S.R.L.- Italy

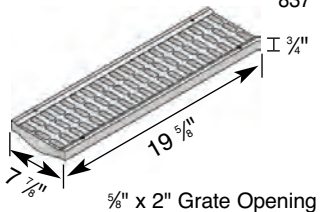
Part No.	Description	Color	Pkg. Qty.	Wt. Ea. (lbs.)	Product Class	Specifications
836	8" x 20" Pedestrian Traffic Channel Gate Requires #829 screws. 4 screws per grate.  (See pg. 47)	Light Gray	1	1.55	25IN	NDS #836, 8" Wide UV protected high impact Polyolefin pedestrian traffic channel grate. Open surface area 11.70 square inches per foot. 15.33 GPM per foot.
 <p>1/4" Grate Opening</p>		ADA Compliant				

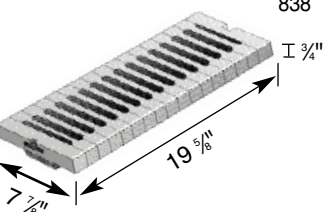
Part No.	Description	Color	Pkg. Qty.	Wt. Ea. (lbs.)	Product Class	Specifications
837	8" x 20" Light Traffic Channel Gate Requires #829 screws. 4 screws per grate.  (See pg. 47)	Light Gray	1	3.00	25IN	NDS #837, 8" Wide UV protected high impact Polyolefin light traffic channel grate. Open surface area 26.94 square inches per foot. 35.29 GPM per foot.
 <p>5/8" x 2" Grate Opening</p>		ADA Compliant				

Part No.	Description	Color	Pkg. Qty.	Wt. Ea. (lbs.)	Product Class	Specifications
838	8" x 20" Load Star Heavy Traffic Channel Gate* Requires #829 screws. 4 screws per grate.  (See pg. 47)	Light Gray	1	4.00	25IN	NDS #838, 8" Wide UV protected high impact glass reinforced nylon heavy traffic channel grate. Open surface area 30.85 square inches per foot. 40.41 GPM per foot.
 <p>1/2" x 5 3/4" Grate Opening</p>		ADA Compliant				

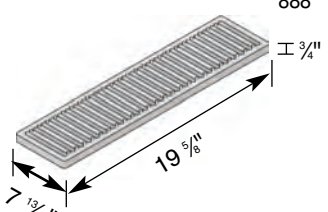
Part No.	Description	Color	Pkg. Qty.	Wt. Ea. (lbs.)	Product Class	Specifications
888	8"x20" Cast Iron Channel Gate #829 screws may be used. 4 screws per grate.  (See pg. 47)	Black	1	14.00	25IN	NDS #888, 8" Wide Heavy Duty Cast Iron Heavy Traffic Channel Gate. Open surface area 41.25 square inches per foot. 54.04 GPM per foot.
 <p>5/16" x 6 1/8" Grate Opening</p>		ADA Compliant				

8" PRO SERIES CHANNEL™ DRAINS

Patented

MODULAR CHANNEL DRAINS

*Produced under license of First Plast S.R.L.- Italy

Part No.	Description	Color	Pkg. Qty.	Wt. Ea. (lbs.)	Product Class	Specifications
830	8" x 20" Shallow Profile Channel Drain*	Light Gray	1	2.00	25IN	NDS #830, 8" Wide Shallow Profile high impact PVC channel drain with mechanical interlocking joints and UV inhibitors.

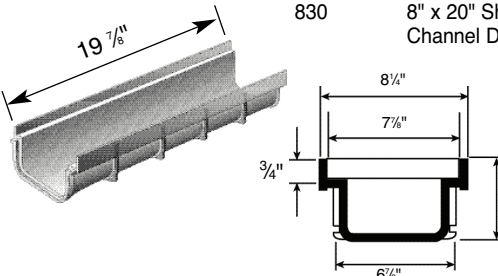

Grate should be recessed 1/8" below finish grade in non traffic applications. Grate should be recessed 1/4" in traffic applications.

Part No.	Description	Color	Pkg. Qty.	Wt. Ea. (lbs.)	Product Class	Specifications
831	8" Shallow Profile End Cap/ 3" S&D SPT Knock Out End Outlet*	Light Gray	1	0.40	25IN	NDS #831, 8" Wide Shallow Profile high impact PVC End Cap/End Outlet.

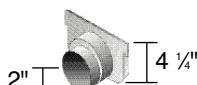

Part No.	Description	Color	Pkg. Qty.	Wt. Ea. (lbs.)	Product Class	Specifications
832	8" Shallow Profile 3" S&D SPT Side Outlet*	Light Gray	1	1.00	25IN	NDS #832, 8" Wide Shallow Profile high impact PVC Bottom/Side Outlet.

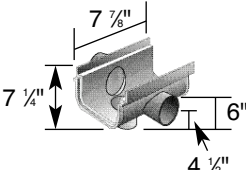

Bottom outlet fits 4" S&D pipe, 3" S&D fittings

Part No.	Description	Color	Pkg. Qty.	Wt. Ea. (lbs.)	Product Class	Specifications
833	8" x 20" Deep Profile Channel Drain	Light Gray	1	3.00	25IN	NDS #833, 8" Wide Deep Profile high impact PVC channel drain with mechanical interlocking joints and UV inhibitors.

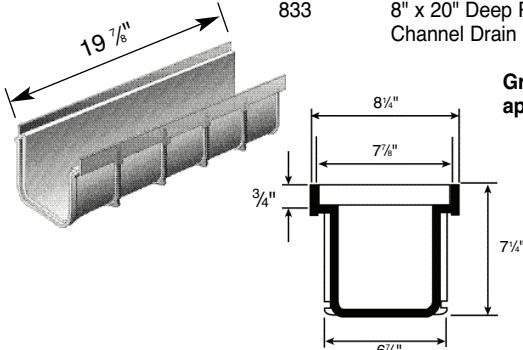

Grate should be recessed 1/8" below finish grade in non traffic applications. Grate should be recessed 1/4" in traffic applications.

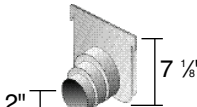

Part No.	Description	Color	Pkg. Qty.	Wt. Ea. (lbs.)	Product Class	Specifications
834	8" Deep Profile End Cap/ 3"&4" S&D SPT Knock Out End Outlet	Light Gray	10	1.20	25IN	NDS #834, 8" Wide Deep Profile high impact PVC End Cap/End Outlet.



Note: All dimensions are nominal. All weights are for shipping purposes only. Availability is subject to change.

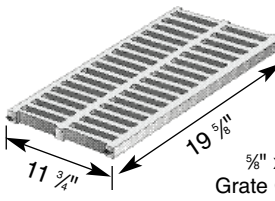

*Produced under license of First Plast S.R.L.- Italy

Part No.	Description	Color	Pkg. Qty.	Wt. Ea. (lbs.)	Product Class	Specifications
847	12" x 20" Light Traffic Channel Grate*	Gray	1	4.64	25IN	NDS #847, 12" Wide UV protected high impact PVC light traffic channel grate. Open surface area 48.77 square inch/foot. 63.89 GPM per foot.

(See pg. 47)

Part No.	Description	Color	Pkg. Qty.	Wt. Ea. (lbs.)	Product Class	Specifications
845	12"x20" Cast Iron Heavy Traffic Channel Grate	Black	1	31.92	25IN	NDS #845, 12" wide cast iron heavy traffic channel grate. Open surface area 38.58 square inches per foot. 50.54 GPM per foot.

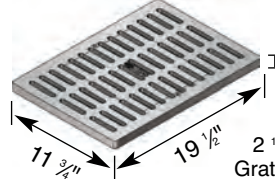

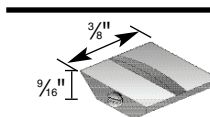

(See pg. 47)

Part No.	Description	Color	Pkg. Qty.	Wt. Ea. (lbs.)	Product Class	Specifications
849	Grate Security Clip*	Gray	10	0.40	25IN	For use with 845 and 847 grates and 840 or 843 channels only (2 per grate). Mounts inside Channel Drain and secures grate. Screw and nut included.

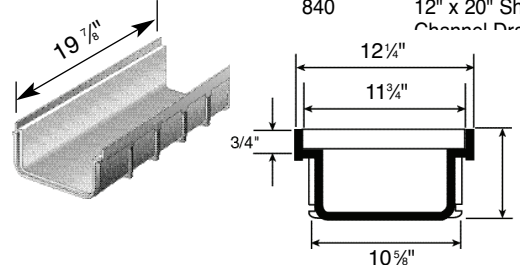

Part No.	Description	Color	Pkg. Qty.	Wt. Ea. (lbs.)	Product Class	Specifications
840	12" x 20" Shallow Profile Channel Drain	Light Gray	1	4.00	25IN	NDS #840, 12" Wide Shallow profile UV protected high impact PVC channel drain with mechanical Interlocking Joints. ite should be recessed 1/8" below finish grade in non traffic applications. Grate should be recessed 1/4" in traffic applications.



Part No.	Description	Color	Pkg. Qty.	Wt. Ea. (lbs.)	Product Class	Specifications
841	12" Shallow Profile End Cap/ 4" S&D SPT Knock Out End Outlet	Light Gray	1	1.00	25IN	NDS #841, 12" Wide Shallow Profile high impact PVC End Cap/End Outlet.

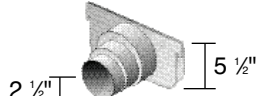

Part No.	Description	Color	Pkg. Qty.	Wt. Ea. (lbs.)	Product Class	Specifications
843	12" x 20" Deep Profile Channel Drain*	Light Gray	1	6.00	25IN	NDS #843, 12" Wide Deep Profile UV protected high impact PVC channel drain with mechanical interlocking joints. Grate should be recessed 1/8" below finish grade in non traffic applications. Grate should be recessed 1/4" in traffic applications.

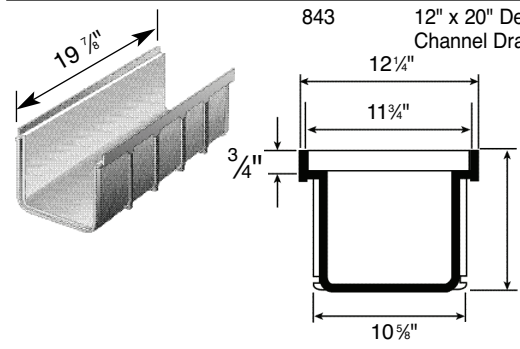

Part No.	Description	Color	Pkg. Qty.	Wt. Ea. (lbs.)	Product Class	Specifications
844	12" Deep Profile End Cap/ 4" S&D SPT Knock Out End Outlet*	Light Gray	1	1.60	25IN	NDS #844, 12" Wide Deep Profile high impact PVC End Cap/End Outlet.

